

### OPTION F (TALL SHOWCASE - GREY)

### 5M x 3M Hall of Fame Booth

五米乘三米品牌薈萃廊特級攤位

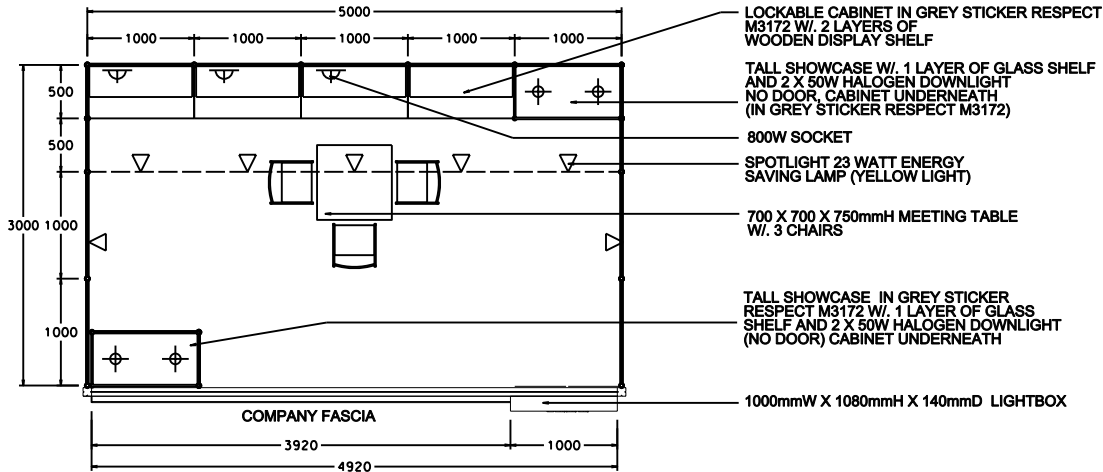

PLAN

CONCEALED LIGHT TROUGH TO HIGHLIGHT COMPANY FASCIA (IN GREY STICKER RESPECT M3172/PANTONE 431C)

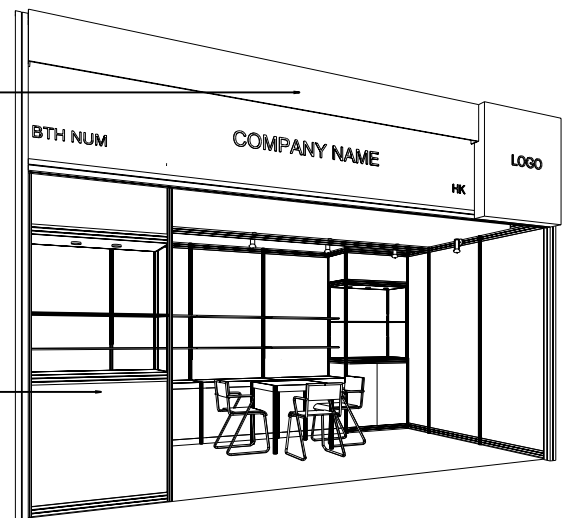

PERSPECTIVE

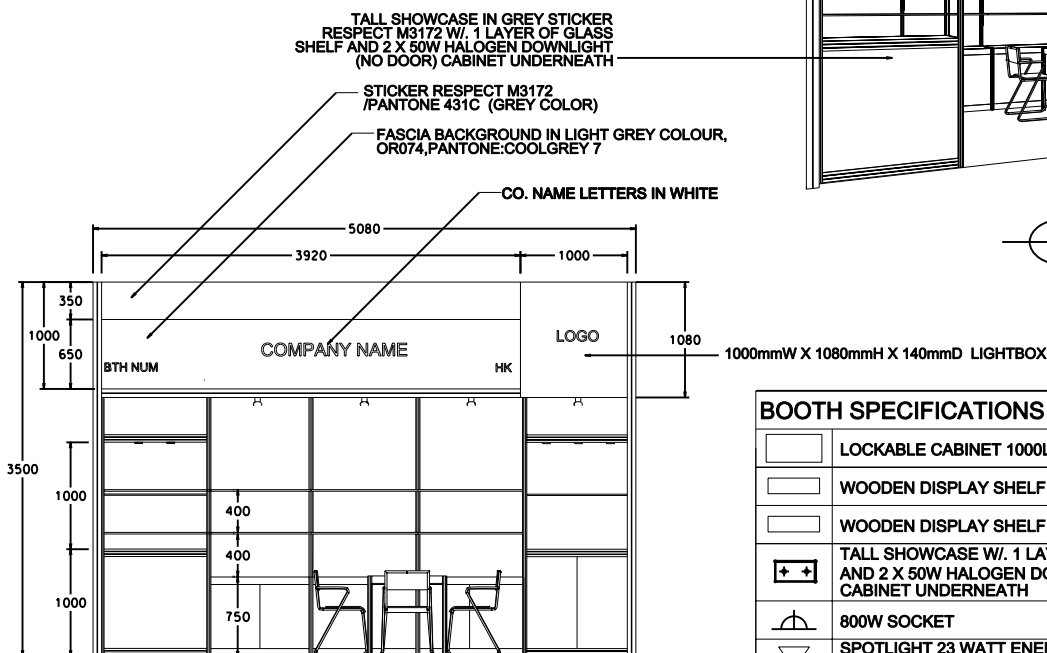

ELEVATION

BOOTH SPECIFICATIONS		QTY.
	LOCKABLE CABINET 1000L x 500W x 750H mm	4
	WOODEN DISPLAY SHELF FLAT (3000W X 300D mm)	2
	WOODEN DISPLAY SHELF FLAT (1000W X 300D mm)	2
	TALL SHOWCASE W/ 1 LAYER OF GLASS SHELF AND 2 X 50W HALOGEN DOWNLIGHT (NO GLASS DOOR), CABINET UNDERNEATH	2
	800W SOCKET	3
	SPOTLIGHT 23 WATT ENERGY SAVING LAMP (YELLOW LIGHT)	7
	700W x 700D x 750H mm MEETING TABLE	1
	BLACK LEATHER CHAIR	3
	CEILING BEAM	5M
	RUBBISH BIN & CARPET (15sqm.)	

### OPTION F (TALL SHOWCASE - GREY)

### 5M x 3M Hall of Fame Booth (Right Corner)

五米乘三米品牌薈萃廊特級攤位 (右邊角位)

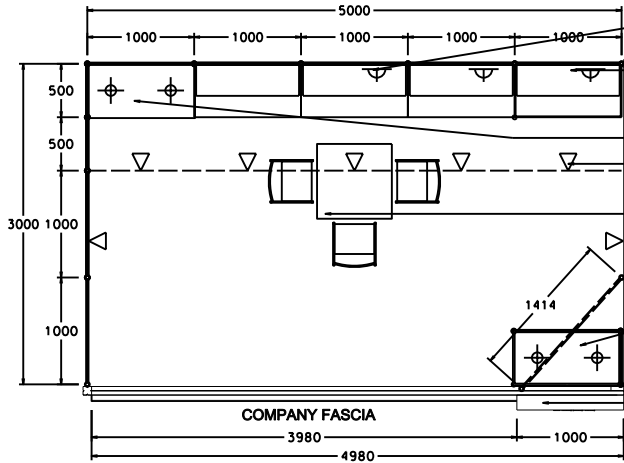

PLAN

- 800W SOCKET
- LOCKABLE CABINET IN GREY STICKER RESPECT M3172 W/ 2 LAYERS OF WOODEN DISPLAY SHELF
- TALL SHOWCASE W/ 1 LAYER OF GLASS SHELF AND 2 X 50W HALOGEN DOWNLIGHT (NO DOOR, CABINET UNDERNEATH (IN GREY STICKER RESPECT M3172)
- SPOTLIGHT 23 WATT ENERGY SAVING LAMP (YELLOW LIGHT)
- 700 X 700 X 750mm MEETING TABLE W/ 3 CHAIRS
- TALL SHOWCASE IN GREY STICKER RESPECT M3172 W/ 1 LAYER OF GLASS SHELF AND 2 X 50W HALOGEN DOWNLIGHT (NO DOOR) CABINET UNDERNEATH
- 1000mmW X 1080mmH X 140mmD LIGHTBOX

CONCEALED LIGHT TROUGH TO HIGHLIGHT COMPANY FASCIA (IN GREY STICKER RESPECT M3172/PANTONE 431C)

TALL SHOWCASE IN GREY STICKER RESPECT M3172 W/ 1 LAYER OF GLASS SHELF AND 2 X 50W HALOGEN DOWNLIGHT (NO DOOR) CABINET UNDERNEATH

STICKER RESPECT M3172 /PANTONE 431C (GREY COLOR)

FASCIA BACKGROUND IN LIGHT GREY COLOUR, OR074,PANTONE:COOLGREY 7

CO. NAME LETTERS IN WHITE

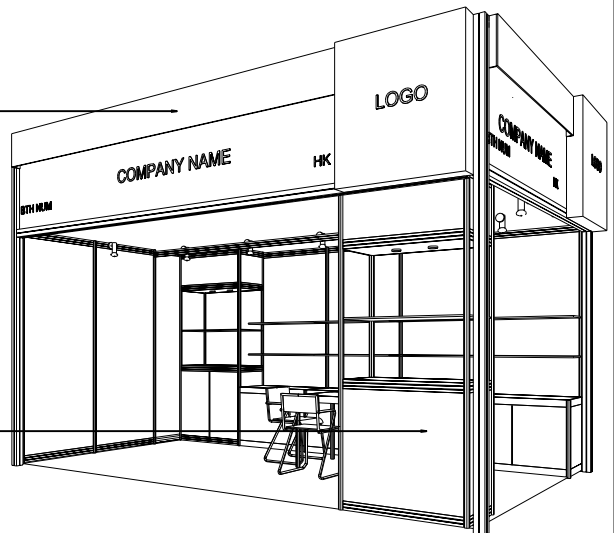

PERSPECTIVE

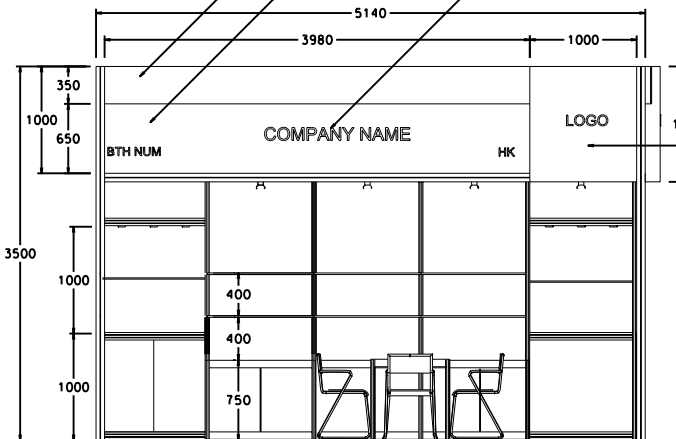

ELEVATION

1000mmW X 1080mmH X 140mmD LIGHTBOX

BOOTH SPECIFICATIONS		QTY.
	LOCKABLE CABINET 1000L x 500W x 750H mm	4
	WOODEN DISPLAY SHELF FLAT (3000W X 300D mm)	2
	WOODEN DISPLAY SHELF FLAT (1000W X 300D mm)	2
	TALL SHOWCASE W/ 1 LAYER OF GLASS SHELF AND 2 X 50W HALOGEN DOWNLIGHT (NO GLASS DOOR), CABINET UNDERNEATH	2
	800W SOCKET	3
	SPOTLIGHT 23 WATT ENERGY SAVING LAMP (YELLOW LIGHT)	7
	700W x 700D x 750H mm MEETING TABLE	1
	BLACK LEATHER CHAIR	3
	CEILING BEAM	5M
	RUBBISH BIN & CARPET (15sqm.)	

### OPTION F (TALL SHOWCASE - GREY)

### 5M x 3M Hall of Fame Booth (Left Corner)

五米乘三米品牌薈萃廊特級攤位 (左邊角位)

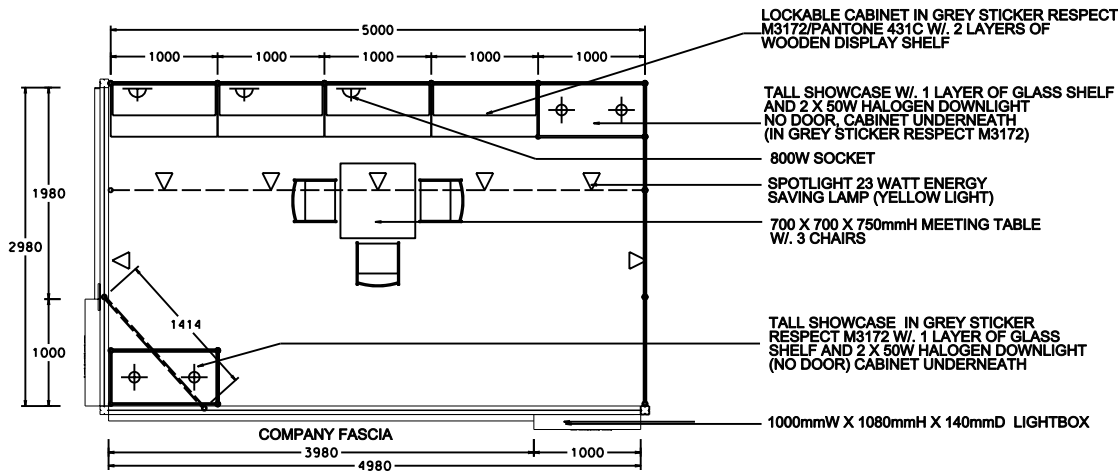

PLAN

CONCEALED LIGHT TROUGH TO HIGHLIGHT COMPANY FASCIA (IN GREY STICKER RESPECT M3172/PANTONE 431C)

TALL SHOWCASE IN GREY STICKER RESPECT M3172 W/ 1 LAYER OF GLASS SHELF AND 2 X 50W HALOGEN DOWNLIGHT (NO DOOR) CABINET UNDERNEATH

STICKER RESPECT M3172 /PANTONE 431C (GREY COLOR)

FASCIA BACKGROUND IN LIGHT GREY COLOUR, OR074,PANTONE:COOLGREY 7

CO. NAME LETTERS IN WHITE

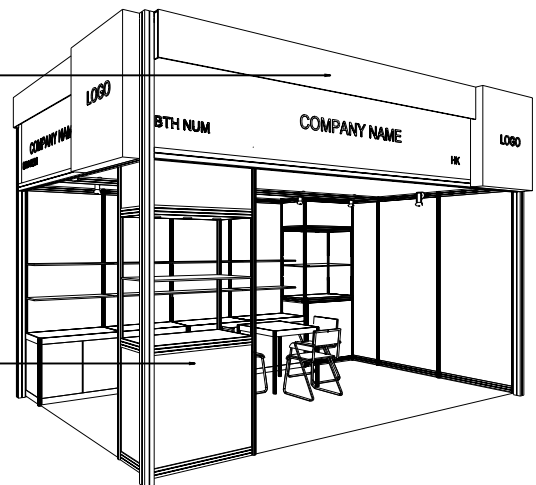

PERSPECTIVE

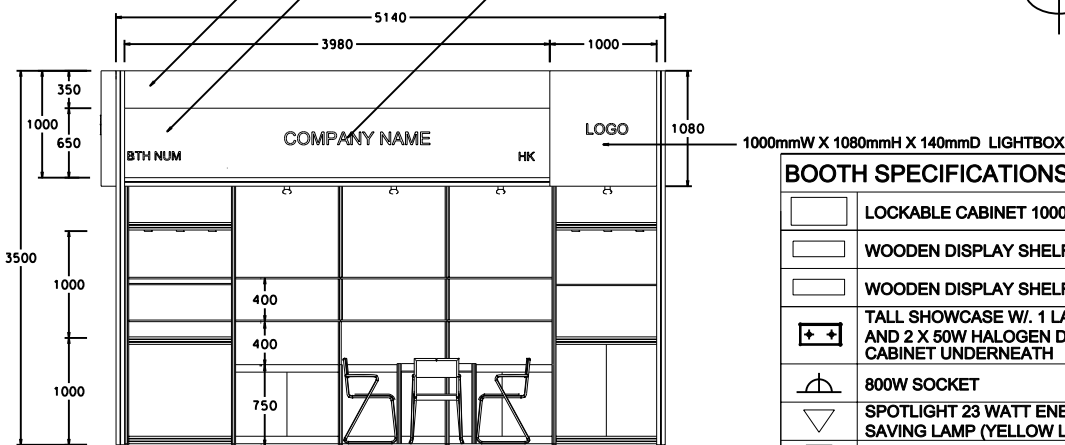

ELEVATION

BOOTH SPECIFICATIONS		QTY.
	LOCKABLE CABINET 1000L x 500W x 750H mm	4
	WOODEN DISPLAY SHELF FLAT (3000W X 300D mm)	2
	WOODEN DISPLAY SHELF FLAT (1000W X 300D mm)	2
	TALL SHOWCASE W/ 1 LAYER OF GLASS SHELF AND 2 X 50W HALOGEN DOWNLIGHT (NO GLASS DOOR), CABINET UNDERNEATH	2
	800W SOCKET	3
	SPOTLIGHT 23 WATT ENERGY SAVING LAMP (YELLOW LIGHT)	7
	700W x 700D x 750H mm MEETING TABLE	1
	BLACK LEATHER CHAIR	3
	CEILING BEAM	5M
	RUBBISH BIN & CARPET (15sqm.)	